

Aluminium Windows & Doors



**WINDOWS
& DOORS**



DESIGNER RANGE
ALUMINIUM



Contents

Why Choose Us?	Page 03	Aluminium Windows	Page 11
Sustainability	Page 05	Aluminium Front Doors	Page 21
Safety and Security	Page 07	Aluminium French & Bi-fold Doors	Page 25
Energy Efficiency	Page 09	Aluminium Skylights	Page 43

Welcome

Introducing our Aluminium Designer range - not only are these products stunningly beautiful and stylish, but they are also masterfully crafted to balance energy efficiency, security and design. We're passionate about every detail of our high-quality products, from the meticulous design and testing to the manufacturing of every major component. We're on a mission to revolutionise aluminium windows, doors, and lanterns. We strive to deliver products that not only operate and perform exceptionally but also look stunning, providing you with comfort and security for many years to come.

At the heart of our ethos is sustainability. We take pride in recycling our own production waste, contributing to closed loop recycling at the Welsh aluminium foundry, where we source the majority

of our aluminium. Our commitment to sustainability runs deep, and we're constantly seeking ways to reduce our environmental impact. We hope that our brochure inspires you for your next home improvement project. Should you need any further information, please don't hesitate to get in touch.

So whether you're looking for a sleek and stylish aluminium window or an elegant and modern door, our Aluminium Designer range has got you covered. With a perfect balance between aesthetics, energy efficiency, and security, our products will transform your home into a comfortable and secure sanctuary. And with our commitment to sustainability, you can be confident that you're making a responsible and eco-friendly choice.





Why Choose Us?

Our commitment to delivering only the highest quality products shines through in everything we do. With our expertly designed and meticulously manufactured range of aluminium systems, crafted right here in the UK. We're dedicated to ensuring you have peace of mind and confidence that the products are built to last.

We believe that great design is all about consistency and attention to detail. That's why our Designer Range aluminium systems are all built on the same ingenious engineering principles and share the same design philosophy. You can trust that our systems are seamlessly compatible, so you can mix and match windows and doors across your home without any compromise on aesthetics, colors, styles, or sightlines.

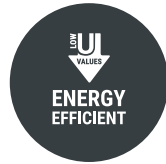

Buy British

Made to the highest standards in our award winning workshops in Britain.

Energy Efficient

u-Values as low as 1.0 w/(m2K).

Extensive Guarantee

Highest quality product with our guarantee to match.

Protect your Home

Optional Secure by Design (Police approved).

Colour Match Guarantee

Windows and doors that match perfectly.

Sustainability

Sustainability is at the heart of everything we do.



Sustainability

Created from one of the most sustainable materials on the planet

Made from the most recycled and abundant metal in the Earth's crust and produced in the most energy efficient aluminium facility in the UK, all Designer Range products are manufactured in the most sustainable way possible. The aluminium profile is created using a state-of-the-art, energy efficient SMS HYBEX press delivering energy

savings of up to 55% compared to traditional presses. The design also vastly reduces fabrication waste, minimising the unnecessary consumption of raw material and helping reduce your window and door's carbon footprint. This coupled to the high level of energy efficiency built into every Designer Range product helps build towards a greener future for all.

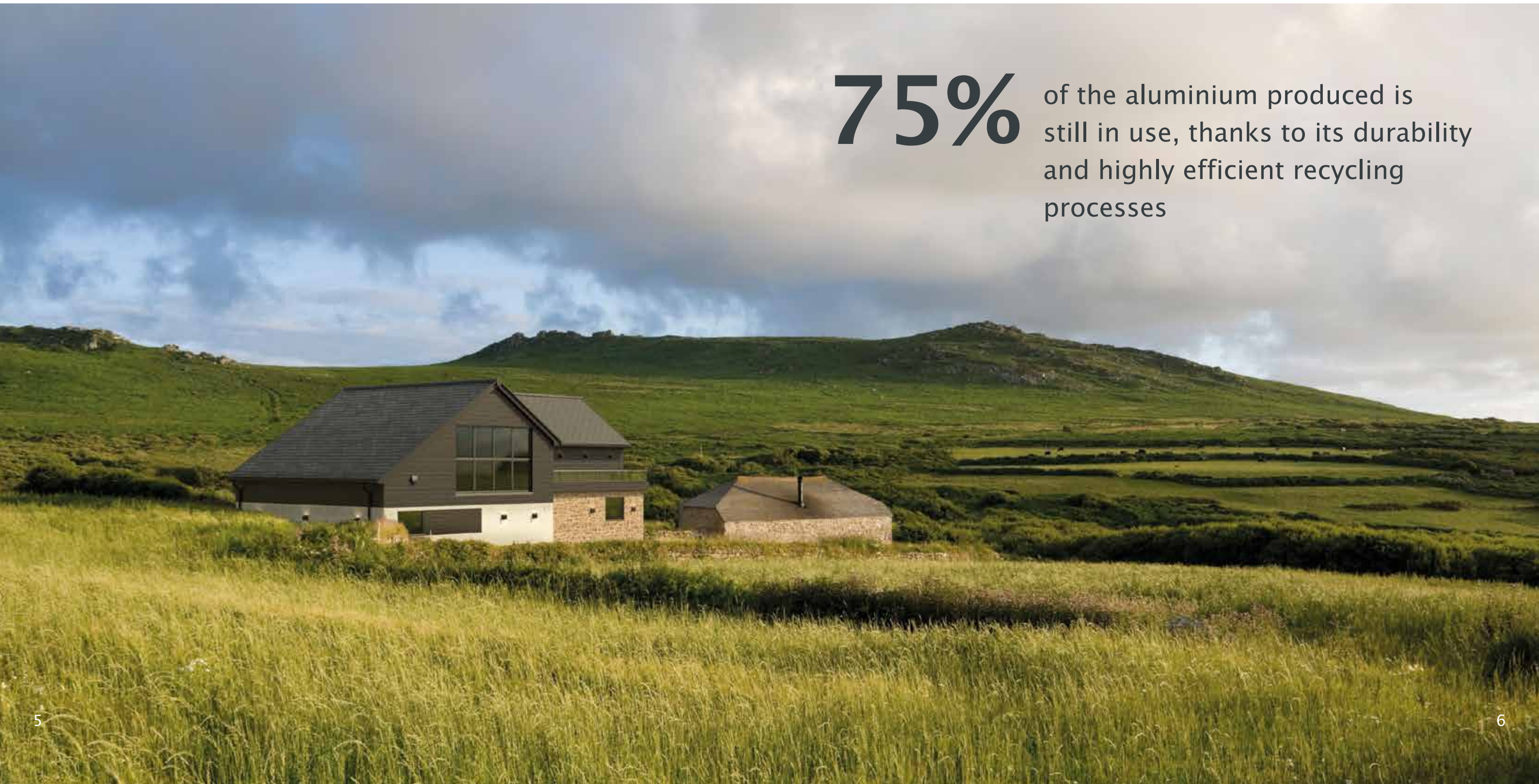

75% of the aluminium produced is still in use, thanks to its durability and highly efficient recycling processes



Safety and Security

Secured by Design

For added peace of mind Designer Range aluminium windows and doors are available with a laminate glass upgrade – for Secured by Design accreditation – the official UK Police initiative ‘designing out crime’ through physical security.

Tested to destruction

With a truly integrated design, built with security in the forefront of our research and development team’s minds, and with features such as hinge protectors being standard across all systems, you can rest assured in the security credentials of Designer Range’s systems. In security testing the Classic system achieved an average maximum load across hinge and lock side of 729Kg (917Kg on hinge 540Kg on lock). A phenomenal result bearing in mind that 306Kg is the required pass test load for a window and 459Kg for doors. Well over twice the required level.

Security built in

The patented corner jointing method securely locks the glass away within a completely sealed unit. This coupled with high security multipoint locking and unique hinge protectors creates unparalleled levels of security. No window in its class is as secure.

PAS24:2016

All Designer Range windows carry PAS24:2016 enhanced security accreditation as standard, so if you are looking for stylish aluminium windows and doors with extra peace of mind – then we have you covered.

High security is built-in as standard across the entire Designer Range, with our beadless range offering the ultimate peace of mind.

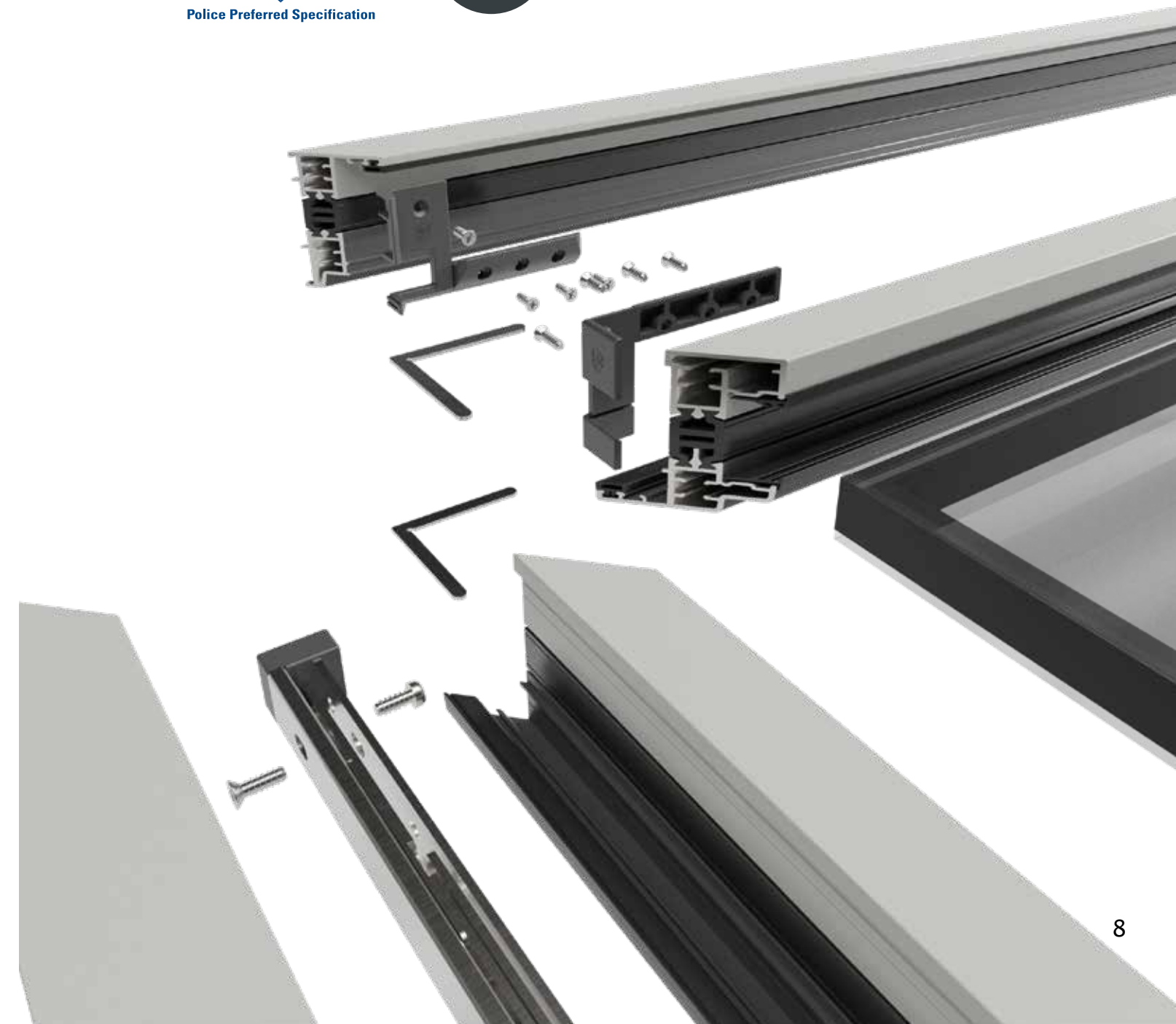

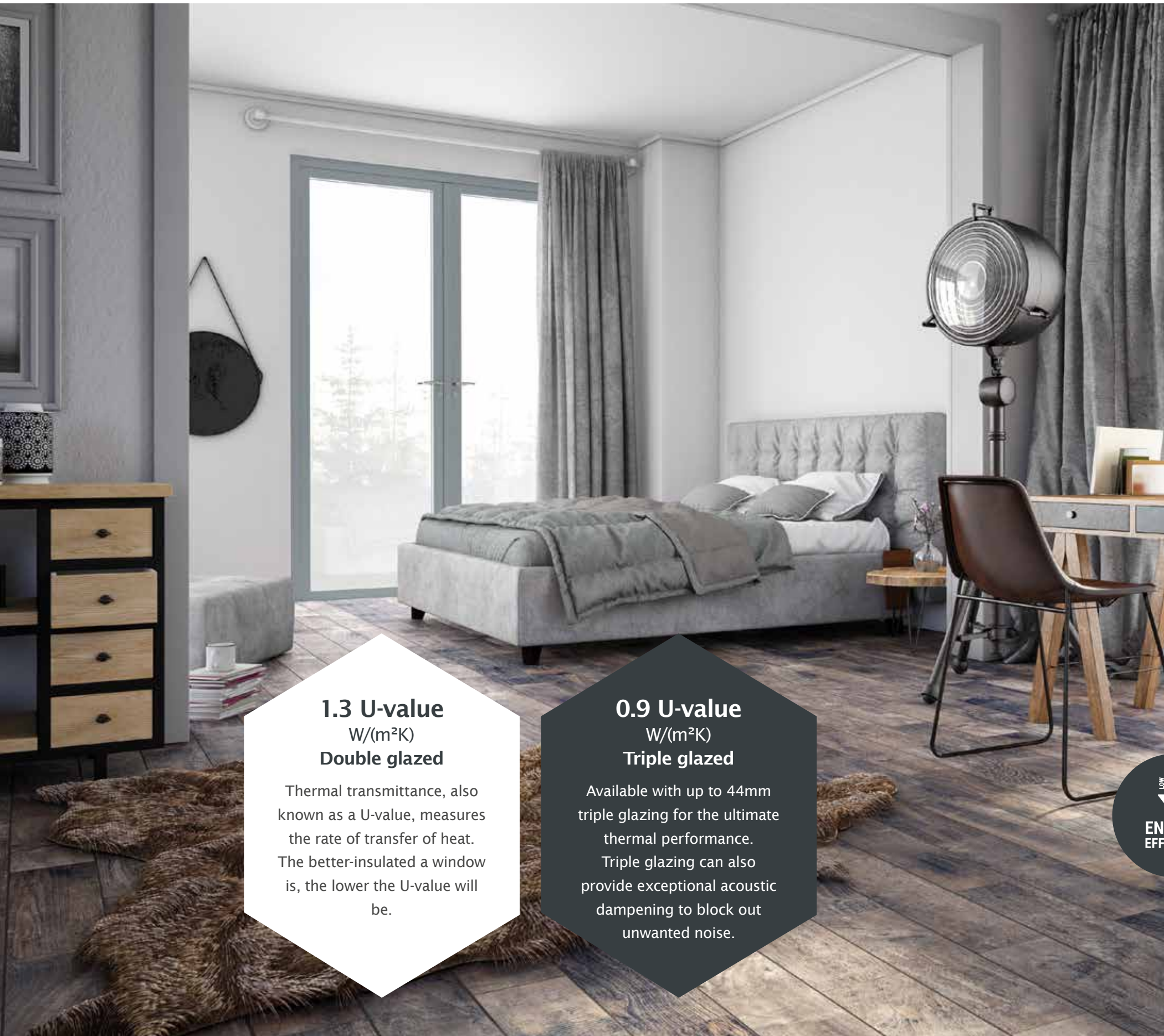

1.3 U-value
W/(m²K)
Double glazed

Thermal transmittance, also known as a U-value, measures the rate of transfer of heat. The better-insulated a window is, the lower the U-value will be.

0.9 U-value
W/(m²K)
Triple glazed

Available with up to 44mm triple glazing for the ultimate thermal performance. Triple glazing can also provide exceptional acoustic dampening to block out unwanted noise.

Energy Efficiency

Our unique Thermlock® closed-cell, insulating chamber, hidden away inside every Designer Range window and door act as a thermal break, creating products with class leading thermal performance.

Keeping homes warm

Cold, crisp lines on the outside hide away our innovative Thermlock® multi-chamber thermal design, helping keep homes well insulated against the worst of the UK weather. This closed-cell, insulating chambers act as a thermal break, working in conjunction with high performance glazing to create class leading thermal performance, far superior to traditional polyamide thermal breaks.

Outstanding performance

Designer Range's double glazed windows, with standard high performance glazing have a U-value as low as 1.3 W/(m²K). While our Prestige triple glazed windows are as low as 0.9W/(m²K), also achieving an A+ WER (Window Energy Rating).

**A+ WER (Window Energy Rating) achievable with triple glazing, A WER with double glazing.*

THE THERMLOCKI®

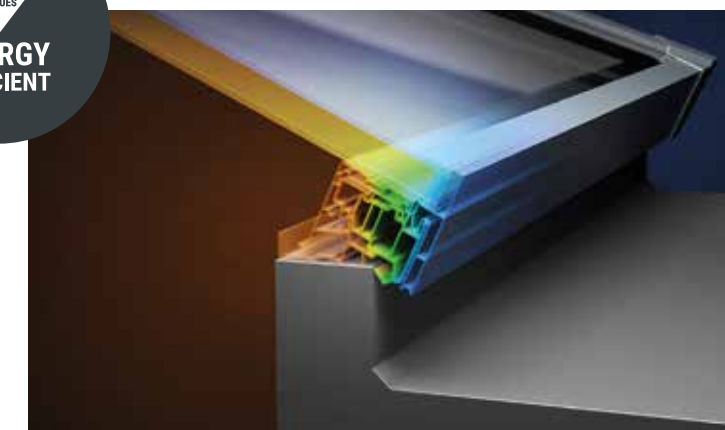
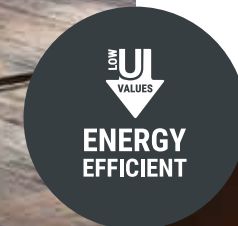



Slim and ultra-secure,
high performance
aluminium windows

Transform your home with our stylish, high performance aluminium windows

Steel Look



Choosing the right windows for your home is an important decision. An investment that makes a real difference to how warm and secure you feel; as well as changing the look of your property. This is why we have designed the Classic system from the ground up. Building on years of experience, we've incorporated many new innovative ideas; creating a warmer, slimmer and more secure window system. Designed for discerning homeowners that aren't willing to compromise, our windows are tailored to those who demand more for their home.

Built around an innovative Thermavic® multi-chamber thermal break, our windows use a patented construction method that offers unsurpassed levels of security. Creating windows that are strong and durable, yet with slim frames that maximise the light flooding into your home. Designer Range aluminium windows are also available in a wide range of colours, letting you express your home's character.

Designed to combine the latest technical innovations with peerless aesthetics

With great looks from every angle - due to our unique construction method

Step into a world of understated refinement and exacting quality standards with our innovative Classic window system. With ultra-slim 59mm sightlines*, this system is designed to maximise the light flooding into your home, creating a beautifully refined architectural look. Our patented construction method uses threaded screws to bind corners tightly together in perfect unison, eliminating the stepping of misaligned corners. This means that each Designer Range aluminium window is individually hand-tuned to perfection,

leaving you with an impeccable finish that perfectly balances form and function.

At Designer Range, we believe that every installation should be as unique as the property it's designed for. That's why our Prestige range is individually tailored to the exact requirements of your home. With a range of different outer frame sizes to accommodate different plaster lines and window reveals, we ensure a perfect, neat finish every time.

**59mm sightlines are optional*

Classic

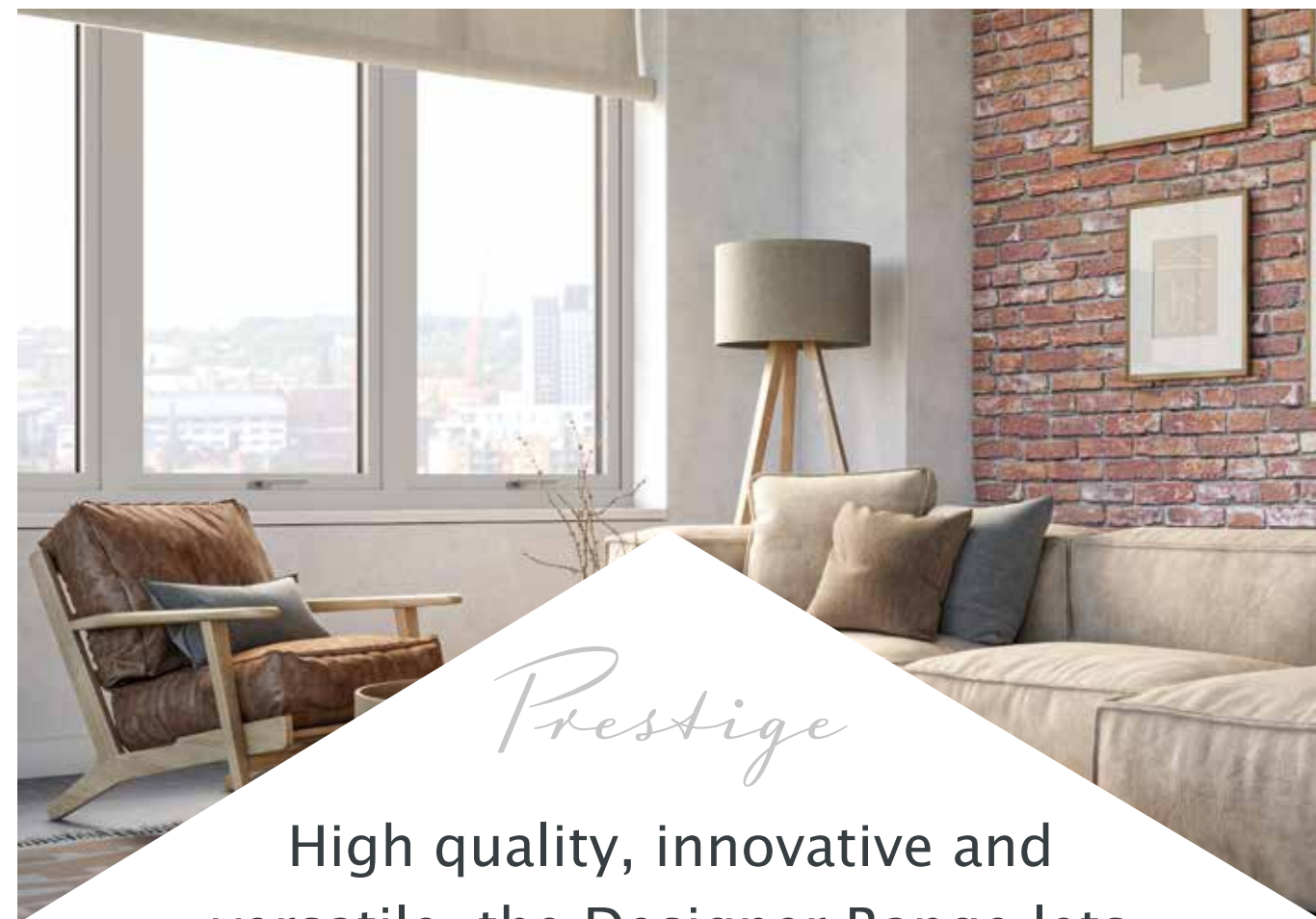

Prestige

High quality, innovative and versatile, the Designer Range lets light flood in to open up interiors

Our versatile 72-80mm wide system is available in casement, French, and fixed windows, designed to be sympathetic to the modern trend for light, airy interiors. Using slim sashes allows more light to flood into your home, helping to create that all-important sense of space and tranquility.

Experience the perfect balance of beauty and function with our Designer Range systems. From the refined elegance of the Classic window system to the versatile and modern Prestige range, our aluminium windows are crafted to the highest standards, using the most innovative techniques and materials available. Each system is designed to work in perfect harmony, ensuring that your home is both beautiful and functional, with a flawless finish that perfectly complements your unique style.



Contemporary

Flush Contemporary

Stepped

Stepped Flush



Flush Contemporary design

With a choice of traditional or contemporary styling

We know that your home's style is unique, and we believe that your windows should reflect that. That's why we offer a range of opening sash styles to choose from, including the traditional 'Stepped' style, inspired by classic steel windows, and the more modern 'Contemporary' style, with its clean, minimalist aesthetic. Whichever style you choose, you can opt for our standard outer frame or our 'Flush' option that perfectly aligns both the perimeter and the opening sash for a seamless look.





Pear Drop Handles (Optional upgrade)
 Unique cranked design provides good clearance between the handle and the window.

Monkeytail Handles (Optional upgrade)
 Elegant design inspired by 19th century ironmongery.



Designer Range Aluminium Window Handles

We understand that choosing the perfect style for your home can be daunting, but don't worry - we're here to help. Our team of experts is always happy to offer advice and guidance to help you select the style that complements your home's unique character and style. Whether you're after a traditional look or a modern vibe, our range of opening sash styles and finishing options means that you can create a look that perfectly suits your tastes and your home. So why not take the first step towards creating your dream home today?

Connoisseur Offset Locking Window Handles
 Standard handles for Prestige Windows and Classic Windows.





Aluminium Front
Doors combine
elegance and
technology





Images are of the panels only, doors feature a stepped design

Aluminium Front Doors: Exquisite Entrance for Your Home

Discover a world of elegance with our 44mm Aluminium Front Doors, meticulously crafted. Each door is encased in a robust 3mm aluminium sheet, promising unparalleled durability coupled with an unrivalled aesthetic appeal.

The Designer Range Aluminium Front Doors are more than a gateway to your home. With a choice of six unique

designs, these doors effortlessly blend state-of-the-art technology with timeless style, making them a captivating feature of your home.

Choose from an array of eight matt colours, including the immensely popular Anthracite Grey and Jet Black, to complement the distinct character of your property. For a touch of classic elegance, we also offer a stunning Gloss White option.

Our Aluminium Front Doors aren't just about aesthetics; they're synonymous with unparalleled security. The triple-glazed units, featuring laminated glass, offer enhanced security, with options for clear or satin glass to suit your preference. Further bolstering your home's security, each door features fully encased locks, with a 3-star cylinder and multi-point locking system.

Invest in our 44mm Aluminium Front Doors – a harmonious blend of design, performance, and uncompromising quality. Experience the perfect marriage of sophistication and innovation, exclusively crafted for your home.

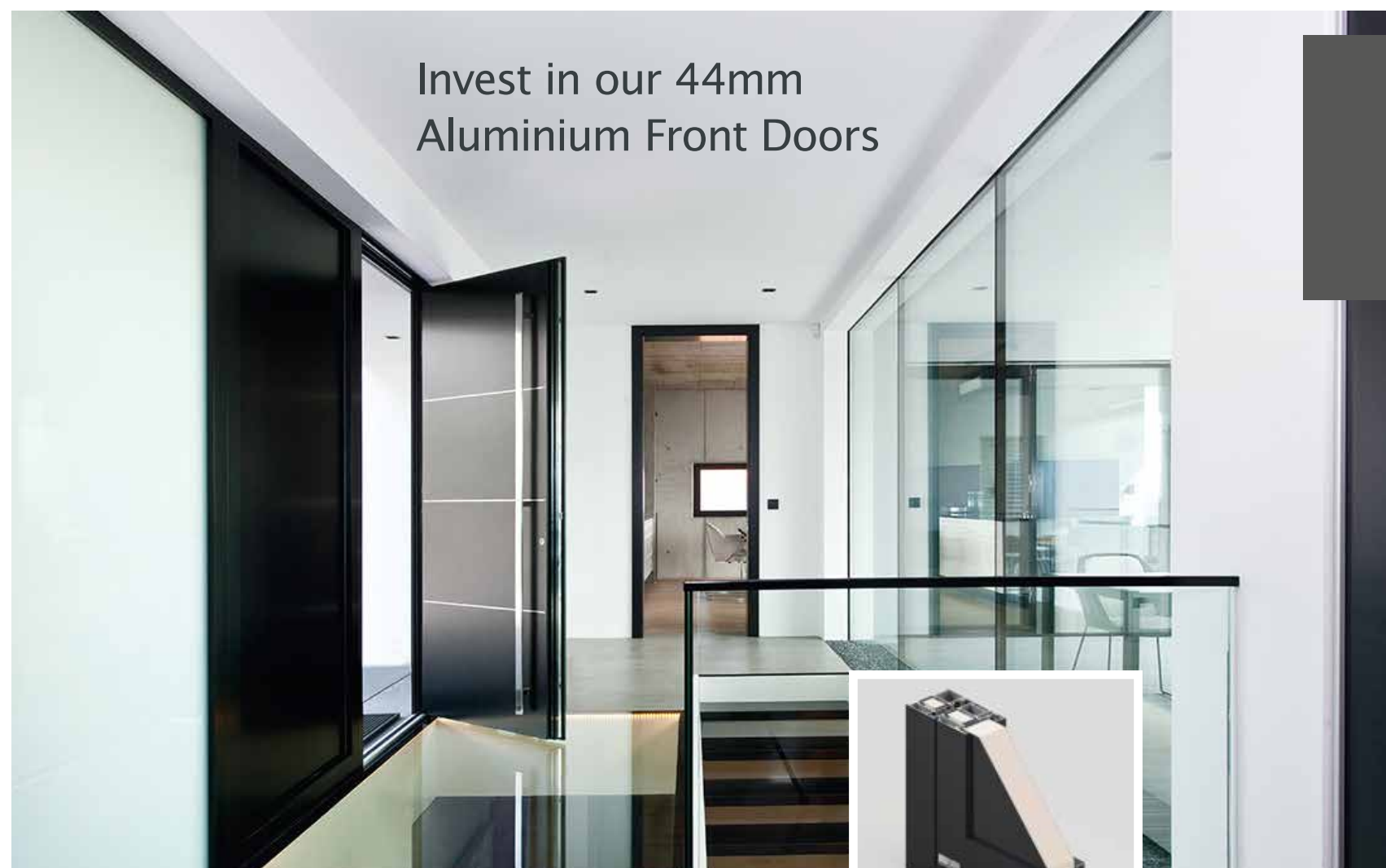

Invest in our 44mm Aluminium Front Doors

Key features:

- ✓ Superior Durability: Encased in a robust 3mm aluminium sheet, our doors offer extraordinary longevity.
- ✓ Exceptional Insulation: With impressive thermal ($U_f = 1.4W(m2K)$) and heat ($UD = 0.88W(m2K)$) insulation ratings, our doors ensure comfort and energy efficiency.
- ✓ Noise Reduction: A sound insulation rating of $R_w = 31$ dB provides a barrier against external noise, preserving your home's tranquillity.
- ✓ Enhanced Security: Triple-glazed units with laminated glass, along with fully encased locks featuring a 3-star cylinder and multi-point locking system, guarantee optimal security.
- ✓ Stylish Design: Choose from six distinct designs and eight matt colours or opt for the classic Gloss White.
- ✓ Elegant Accessories: Each door comes with a sleek stainless steel handrail, available in sizes up to 1400mm.
- ✓ Sustainable and Guaranteed: Designed to minimise environmental impact, our doors come with an assured 10-year guarantee.

Images are for representation purposes only. All doors feature a step and are not flush.



Innovative, high performance French and Bi-fold doors





Prestige

French doors, perfect for making an entrance

The Prestige system covers both single and French doors, so you can be sure of finding the perfect entrance for your home. All styles are offered with Part M compliant, thermally broken aluminium thresholds, ensuring there's no weak point in the thermal performance of your door and helping prevent condensation build-up.

Continuing the high end aesthetics, no fixings are visible in the threshold, and designs follow the same clean, refined looks of our windows.

French doors include an integral finger pull lock eliminating the need for a second handle continuing the clean, minimal aesthetics. A mishandling device also ensures doors are locked in the correct order.

Aluminium Bi-fold doors

Prestige Bi-folds enable you to open up and transform your home. Providing that all important flexibility to enjoy your indoor and outdoor space as one. Combining the refined, architectural look of aluminium and the latest thermal and security technology, leaving you with beautifully balanced Bi-folding doors.

Bi-folding doors should maximise the light flooding into your home, and the enjoyment of your garden or patio. Bringing an improved sense of space and creating panoramic views that can transform interiors. They also need to offer reliable operation, while keeping heating bills low, and would be intruders out.



Open up your home
and fill it with natural light

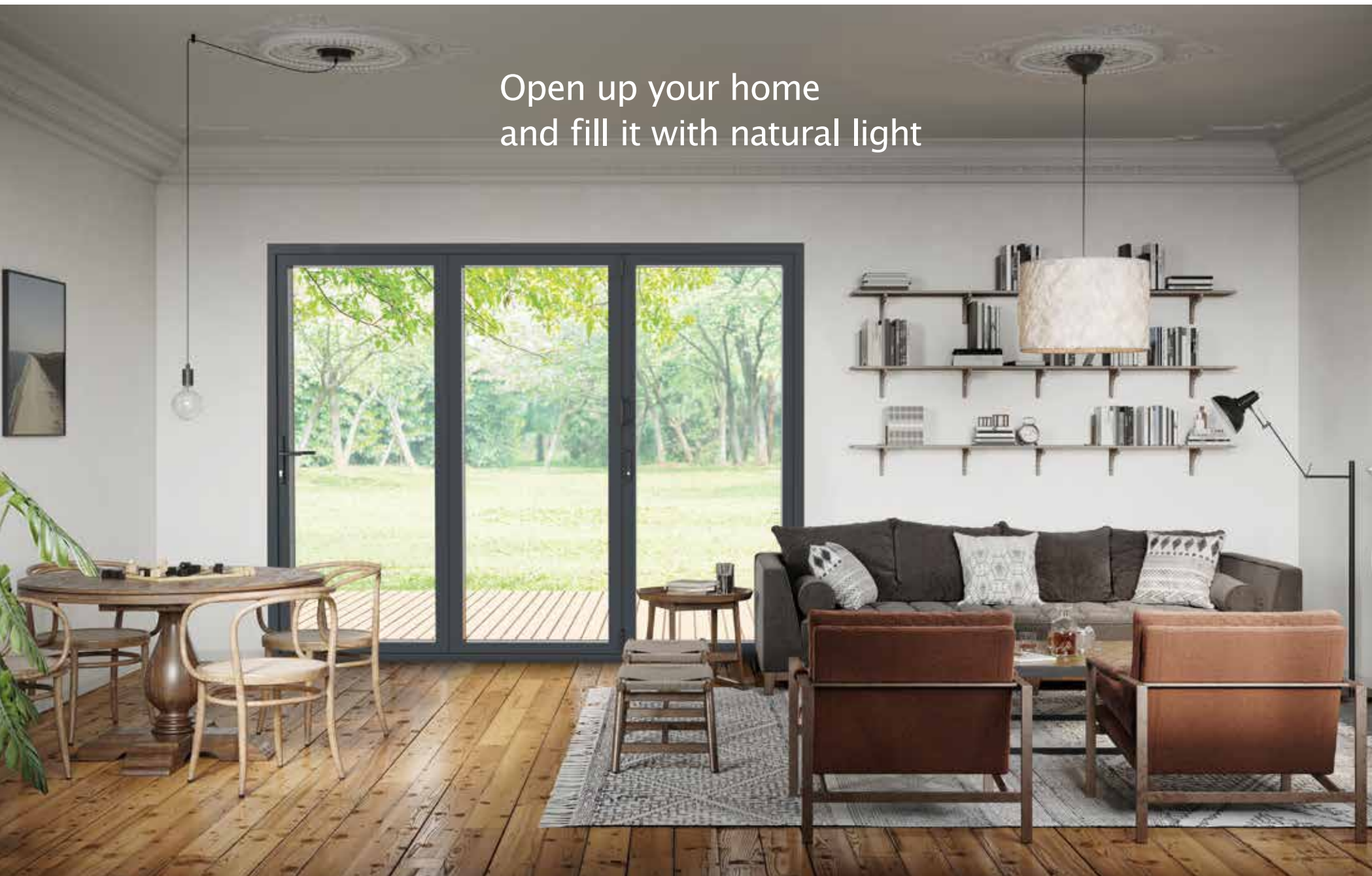

Prestige

That is why we have designed our Prestige Bi-folds to offer you the perfect balance of refined looks, exceptional thermal performance and outstanding operation. Building on years of experience, we've incorporated many new innovative ideas to create a refined aluminium system that's ideal for discerning homeowners who aren't willing to compromise. Unique Thermlock technology provides exceptional thermal performance, while bespoke locking systems and our patented construction method provides unparalleled levels of security. These slim, perfectly balanced Bi-folds are available in stepped and contemporary 'flush' styles, in configurations up to 7 panes wide.

Bring the outside in

Prestige Bi-folds can help soften boundaries, creating an increased sense of space and a seamless transition between your garden and the inside of your home.

Slim, equal 138mm sash-to-sash sightlines ensure light bathes your interiors, even when your doors are closed. Giving you bright airy interiors no matter what style or configuration you choose.

New Steel Look Range

The Designer Range 'Steel Look' aluminium bifold doors. These doors are a perfect blend of classic design and modern functionality, meeting UK building regulations. With a design that mirrors the timeless appeal of industrial steel, they're crafted from durable aluminium, known for its strength and resilience. Plus, these doors not only look stunning but also exceed UK's 'Document L Building Regulations', making them an ideal choice for homeowners who value both style and energy efficiency.

Our 'Steel Look' bifold doors are all about maximising your view and natural light, thanks to their slim sightlines that give a larger glass-to-frame ratio. This not only enhances the aesthetic appeal but also ensures

you enjoy a bright and airy living space. And when it comes to security, these doors are second to none, meeting the PAS24 Security Standard, and even boasting police approval and Secure by Design status.

Our commitment to the environment is reflected in the way these doors are made. Crafted right here in Britain, we use Welsh-sourced aluminium and recycled UK aluminium waste, minimising both waste and energy use. And with a 10-year guarantee and a multitude of customisation options, our 'Steel Look' bifold doors are the perfect blend of style, performance, and reliability. Experience the charm of traditional steel doors with all the advantages of modern materials and design.



Steel Look

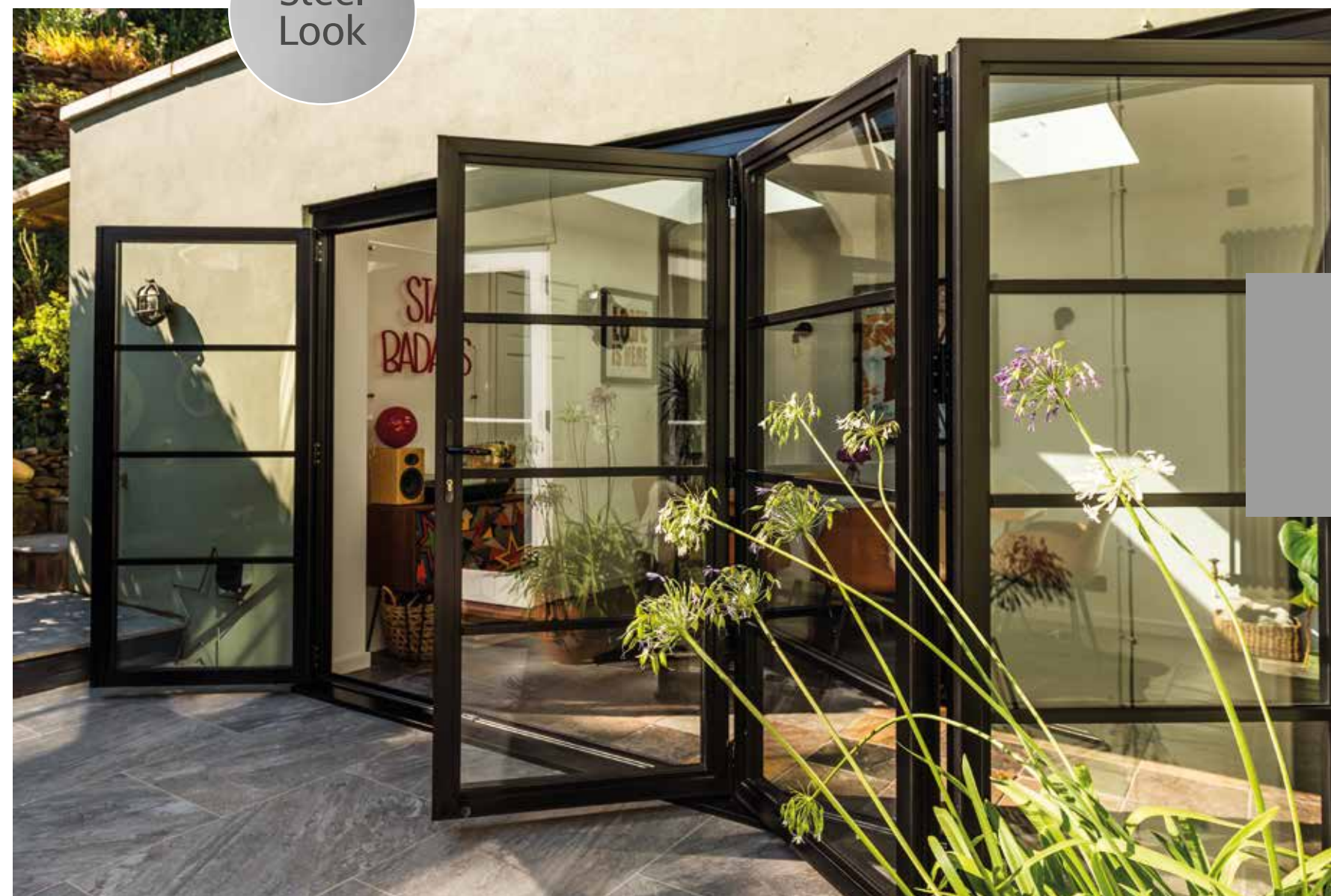

Key features of our 'Steel Look' Bi-fold Doors:

- ✓ Stylish design that emulates the look of traditional steel
- ✓ Built from strong and durable aluminium
- ✓ Compliant with UK's 'Document L Building Regulations' for energy efficiency
- ✓ Slim sightlines for enhanced views and natural light
- ✓ High-level security with PAS24 Security Standard approval
- ✓ Environmentally-friendly manufacturing with locally-sourced and recycled materials
- ✓ 10-year guarantee for peace of mind
- ✓ Variety of customisation options to suit your style preferences



Exceptional thermal performance with Thermlock® technology

Our innovative Thermlock multi-chamber thermal design, hidden away inside each Prestige Bi-folding door, helps keep you well insulated against the worst of the UK weather. These closed-cell, insulating chambers act as thermal breaks, working in conjunction with high performance glazing

to create class leading thermal performance, far superior to traditional polyamide thermal breaks. Designer Range's cills also feature this same technology coupled with innovative in-built weather sealing keeping draughts and rain safely outside.

1.4 U-value
W/(m²K)
Double glazed

Thermal transmittance, also known as a U-value, measures the rate of transfer of heat. The better-insulated a Bi-folding door is, the lower the U-value will be.

1.0 U-value
W/(m²K)
Triple glazed

Available with up to 44mm triple glazing for the ultimate thermal performance. Triple glazing can also provide exceptional acoustic dampening to block out unwanted noise.

Thermlock® technology

**Subject to glass specification, 1.1 U-value for 36mm triple glazed stepped sashes.*



Outstanding security features built into every Bi-fold, keeping you and your home safe

Every element of the Prestige Bi-fold has been designed to keep you and your home secure. All our lock options, including our high security Ultion lock upgrade-offer anti-snap, anti-bump and anti-pick protection while our patented corner jointing method creates exceptionally strong frames, maximising the inherent strength of Designer Range's aluminium construction.

We also use full length security interlocks to protect doors from would-be intruders. So if you are looking for extra peace of mind as standard - we have you covered.



High security locks



Slimline internal handle

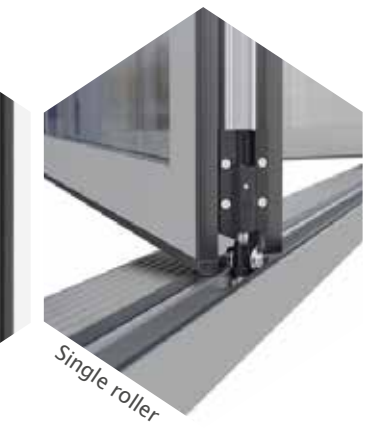

Single roller

Prestige



Four threshold options - all fully weather sealed

Prestige Bi-folds come with four threshold options all featuring fully weather-sealed rebates that keep the worst of the British weather safely outside. These rebates also ensure doors aren't over-centred during operation, helping locks to engage correctly.

Our doors also feature clever concealed drainage, eliminating the need for unsightly drainage cover caps.

We'll help you choose the right threshold for your installation so you get the most out of your new panoramic doors.

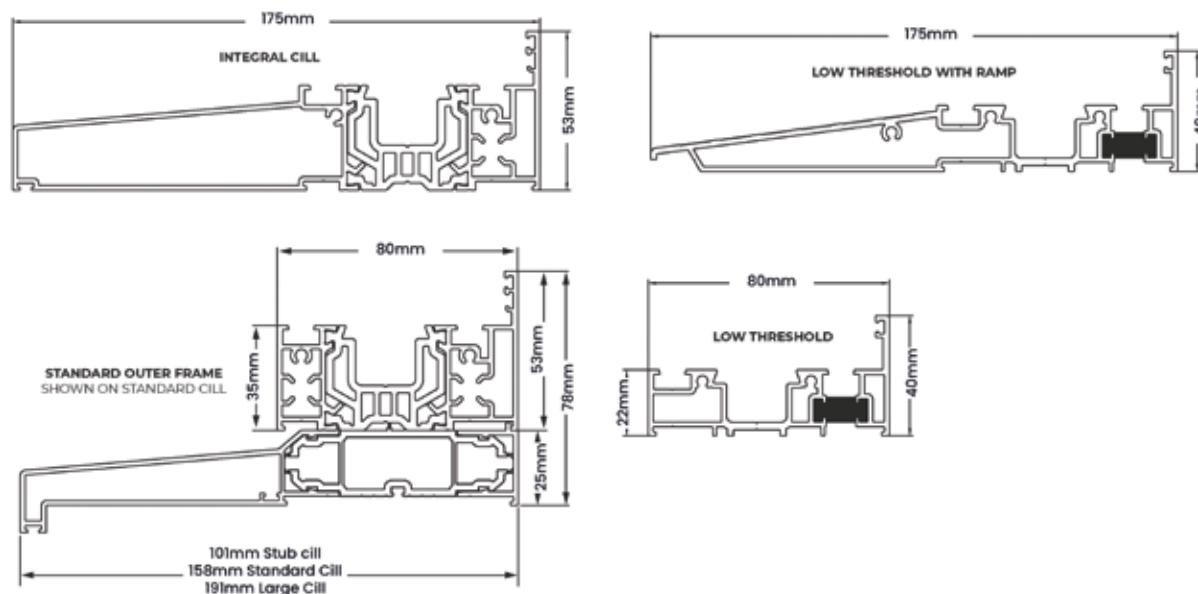

At a glance

- ✓ Up to 7 panes
Including 4/2/2 configurations
- ✓ Single and French door options
- ✓ Max 6.5 x 2.6m
- ✓ Max 1.2m sash width
- ✓ Max 120kg sashes
- ✓ 80mm deep outer frame
- ✓ 72mm deep sashes
- ✓ Slim 138mm sash to sash sightlines
standard across all styles
- ✓ Up to 44mm triple glazing
36mm on stepped sashes

With a wide range of configurations and sizes to suit every project

With a choice of stepped or contemporary, flush and opening sashes, our slim and perfectly balanced doors can be configured to perfectly suit your needs. Available up to 6.5m wide and up to 2.6m tall, the system also accommodates single and French doors, letting you create a unified look to your home.

Depending on the layout of your room you can choose to have your doors split, left and right, or have them all sliding to one side. Including a single 'traffic' door in your configuration is a great way to create an everyday entrance for when the weather's not so good.

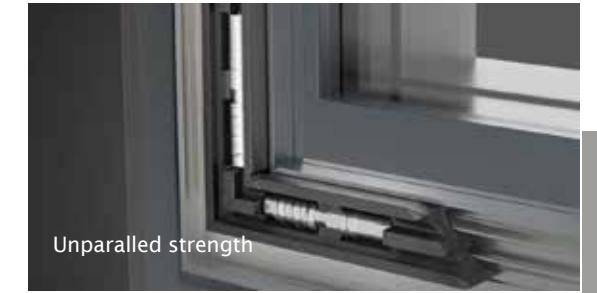

All available in a range of colours and finishes to suit every home

Our Prestige range of Bi-folding doors are available in nine powder coated colours, with the option of choosing a different colour for the interior to help you find the look that is perfect for your property. A further three anodised finishes are available for the ultimate durable and stylish finish.



Steel Look

Quality components for flawless operation

Every element of the Prestige Bi-fold has been engineered to operate perfectly. One-piece stainless steel tracks in the head and threshold ensure smooth and reliable rolling of the sashes, while hinges rated to 120kg help keep every sash perfectly aligned during operation. No aspect of the door has been overlooked and we even use unique tri-material gaskets that feature a low-friction coating for smooth performance and reliable sealing.

Stunning choice of sizes and configurations for your home

Our slim and perfectly balanced doors can be configured to perfectly suit the requirements for your home. Available up to 6.5m wide and up to 2.6m tall, our Bi-fold doors also accommodates single and French doors, letting you create a stunning unified look across your home. Each door panel can be up to 1200mm wide giving you the feeling of being outdoors.

Depending on how you want to use the doors you can choose to have your doors split, left and right, or have them all sliding to one side. Adding a single 'traffic' door in your configuration is a great way to create an everyday entrance for when the weather's not so great.

1 Panel 2 Panels



3 Panels



4 Panels



5 Panels



6 Panels



7 Panels



Maximum door size up to 2.5 high Maximum panel size up to 1200mm wide.



See the choice of Bi-fold configurations and let your installer know what option you prefer, alternatively speak to the installer for their recommendation.

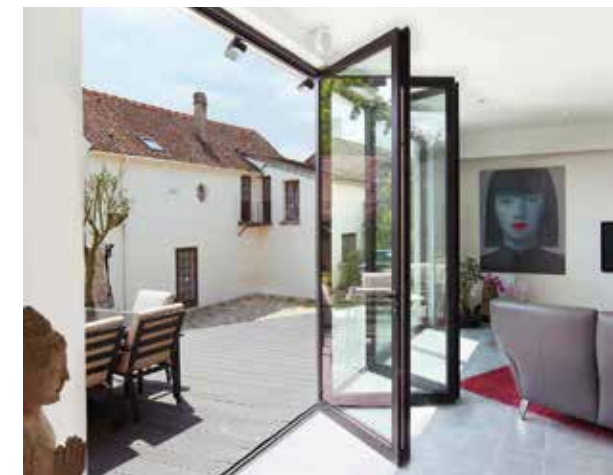

Steel
Look



Designer Range Aluminium Bi-fold Handles

Alpha Handles
Standard handles for Bi-fold, French and single doors.



WHITE



BLACK



ANTHRACITE
GREY



CHROME



SATIN





Secure, Sustainable
and Stylish Roof
Lantern



Flood your home with light with our ultra secure, thermally efficient lanterns



When choosing a roof lantern for your home, you want a product that maximizes natural light while also keeping your home warm and secure. The S1 aluminium roof lantern is an award-winning solution that ticks all those boxes. This product boasts a number of innovative features, including Thermlock® multi-chamber thermal technology, which helps keep your heating bills low. The deep internal bars make for an ultra-strong structure, enabling the lantern to span up to 3.2 x 6m without requiring tie bars. With its ultra-low line aesthetics, this lantern has a stylish, architectural appearance that is further enhanced by hardwearing powder-coated aluminium both inside and out.

The S1 lantern is also designed with security in mind, giving you peace of mind that your home is protected. Additionally, the Designer Range Lanterns feature an integrated LED light channel around the perimeter of the roof, allowing you to add LED lighting that suits your home. Choose the S1 aluminium roof lantern for a warmer, slimmer, and more secure addition to your home.

THERMLOCK®

The UK's most secure lantern, keeps you and your home safe

The innovative construction of the S1 system eliminates the security weaknesses of traditional lantern designs. Features such as anti-tamper screws, enclosed anti-tamper glazing, security tape and the patent pending glass lock, alongside our unique high security ridge end, ensure there isn't an easy way to enter your property via your flat roof lantern. All of these innovative features combine to make Designer Range's S1 system the UK's most secure aluminium lantern roof.

A laminate glass upgrade is also available for extra security if required. So if you are looking for a lantern that comes with extra peace of mind as standard - then we have you covered.

Whatever the weather Thermlock® technology helps keep you comfortable and heating bills lower

The S1 lantern combines aluminium's clean lines with exceptional thermal performance and features our innovative Thermlock® multi-chamber technology to keep you and your property well insulated against the worst of the UK weather. This coupled to high performance 28mm glazing means our lantern roofs offer class leading thermal performance, far superior to traditional polyamide systems based around 24mm glazing. A unique co-extruded perimeter seal also ensures draughts and rain are kept safely outside. 28mm glazing also allows acoustic dampening glass to be fitted if required.

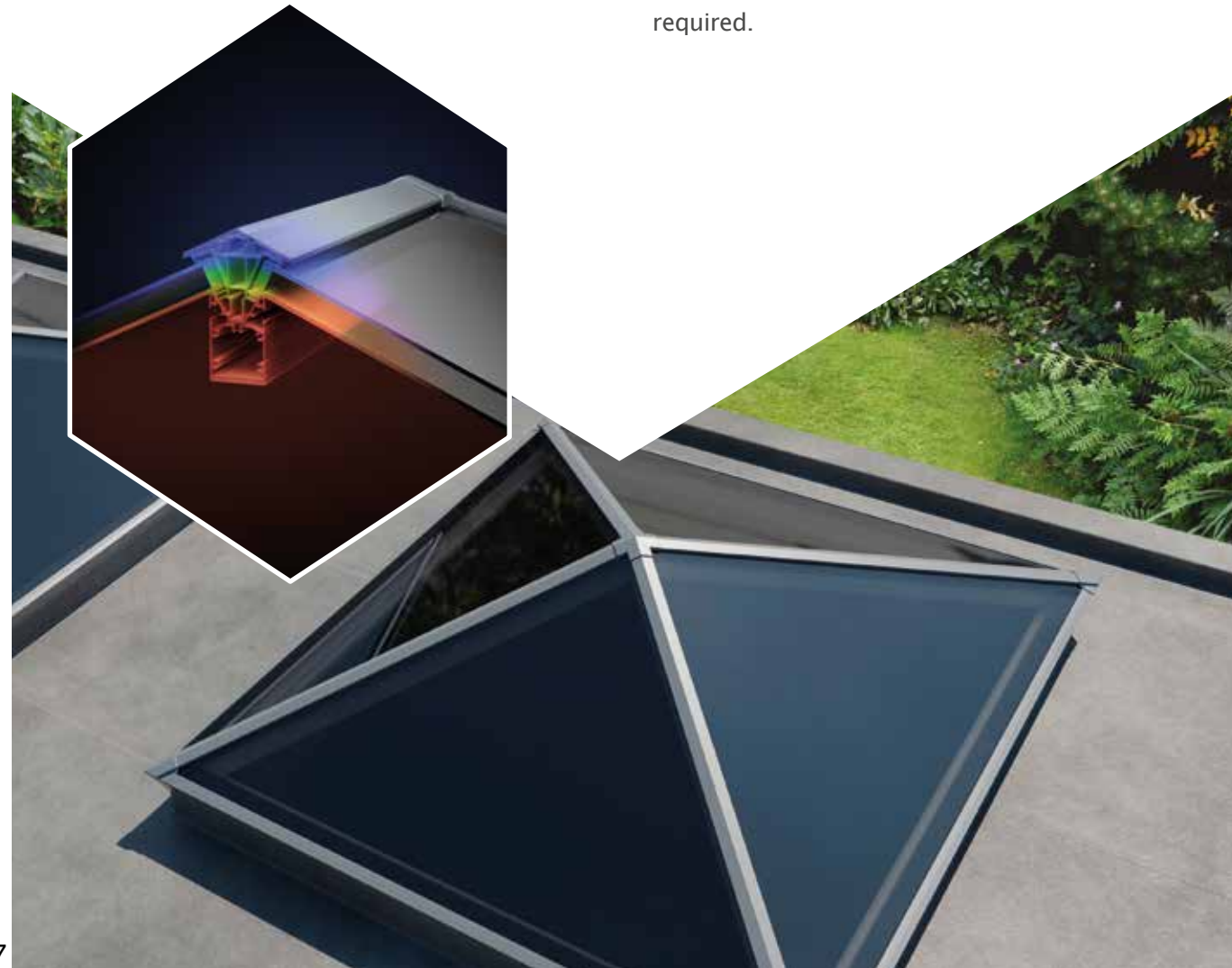

With a wide range of styles and sizes to suit every project

Designer Range aluminium roof lanterns are available in a choice of 10 styles from square 'pyramid' designs to grander options suitable for larger 'orangery' style installations. Maximum sizes range from 2.4 up to an impressive 6m long, all set at a 25° pitch and all weather rated for the whole of the UK*.

Designer Range lanterns are available in three standard powder coated colours, with the option of choosing a different colour for the interior to help you create the look that is perfect for your property. Bespoke colours can also be ordered to accent, or match your particular project requirements.

Range of styles

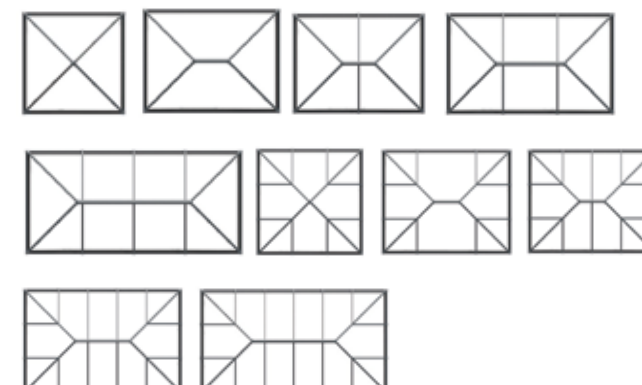

Standard colours

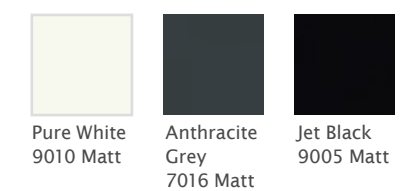

Option of choosing a different colour inside.

All available in a range of colours and finishes to suit every home

Our range of windows and doors are available in nine powder coated colours, with the option of choosing a different colour for the interior to help you find the look that is perfect for your property. A further three metallic finishes are available for the ultimate durable and stylish finish.

Traditional Colours



Character Premium Colours



Paragon Matallic Colours

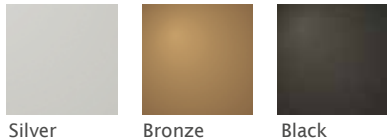

Please note; due to the nature of the manufacturing process and the differences in the methods used to represent these colours in print we cannot guarantee an exact colour match with the colours shown. The RAL colour references are also provided as a guide only.





DESIGNER RANGE ALUMINIUM



120A Wimborne Road West, Wimborne, Dorset, BH21 2DT



Tel **01202 849 619**

Email sales@t&mglassltd.co.uk

www.tandmglass.com

